

MDT 109

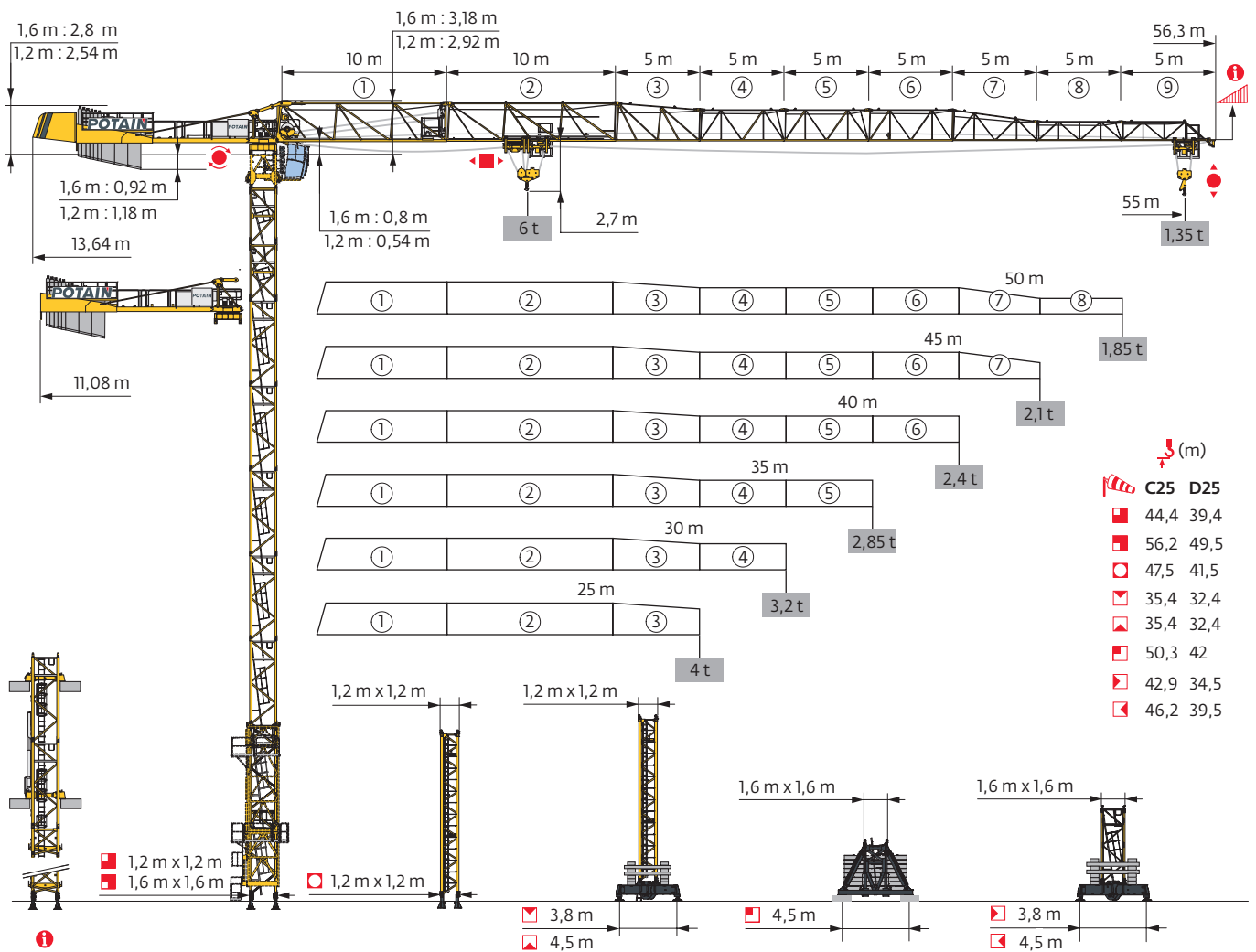

Potain Plus



Power Control

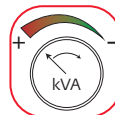

POTAIN®
CONNECT



Top Site

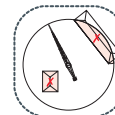

Anti-collision
systems

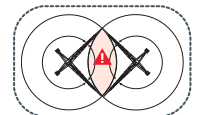

Mât - Réactions / Mast - Reaktionskräfte / Mast - Reactions / Mástil - Reacciones / Torre - Reazioni
 Tramo - Reacções / Реакция опор мачты

1,2 m City - P 12D - C25								
Δ/ΔΔ\ (m)	25	30	35	40	45	50	55	
(m)	37	37	37	37	37	37	37	
/P _r (m)	37	37	37	37	37	37	37	
	7,5 m	1	1	1	1	1	1	
	10,5 m	3	3	3	3	3	3	
F2 (t)	●	90	90	87	89	92	93	94
	■	136	136	137	139	140	140	140
F3 (t)	●	70	69	66	67	69	69	70
	■	119	119	118	120	120	120	119
(m) D25	34	34	34	34	34	34	34	
/P _r (m) D25	34	34	34	34	34	34	34	

1,2 m City - P 12ER - C25								
Δ/ΔΔ\ (m)	25	30	35	40	45	50	55	
(m)	44,5	44,5	47,5	44,5	44,5	44,5	44,5	
/P _r (m)	44,5	44,5	47,5	44,5	44,5	44,5	44,5	
	7,5 m	2	2	1	2	2	2	
	10,5 m	3	3	4	3	3	3	
F2 (t)	●	110	109	115	108	113	115	116
	■	212	212	245	211	216	216	216
F3 (t)	●	88	86	91	84	88	89	90
	■	193	192	225	190	194	194	193
(m) D25	41,5	41,5	41,5	41,5	41,5	41,5	41,5	
/P _r (m) D25	41,5	41,5	41,5	41,5	41,5	41,5	41,5	

1,2 m City - ZC 2030 - - C25								
Δ/ΔΔ\ (m)	25	30	35	40	45	50	55	
(m)	35,4	35,4	35,4	35,4	35,4	35,4	35,4	
/P _r (m)	35,4	35,4	35,4	35,4	35,4	35,4	35,4	
	7,5 m	2	2	2	2	2	2	
	10,5 m	2	2	2	2	2	2	
F1 (t)	●	50	50	48	50	50	52	52
	■	61	60	60	62	62	62	62
(m) D25	29,4	30,9	30,9	30,9	30,9	30,9	32,4	
/P _r (m) D25	29,4	30,9	30,9	30,9	30,9	30,9	32,4	

1,2 m City - ZD 2030 - - C25								
Δ/ΔΔ\ (m)	25	30	35	40	45	50	55	
(m)	35,4	35,4	35,4	35,4	35,4	35,4	35,4	
/P _r (m)	35,4	35,4	35,4	35,4	35,4	35,4	35,4	
	7,5 m	2	2	2	2	2	2	
	10,5 m	2	2	2	2	2	2	
F1 (t)	●	43	41	41	42	43	43	44
	■	51	50	50	52	51	52	51
(m) D25	32,4	32,4	32,4	32,4	32,4	32,4	32,4	
/P _r (m) D25	32,4	32,4	32,4	32,4	32,4	32,4	32,4	

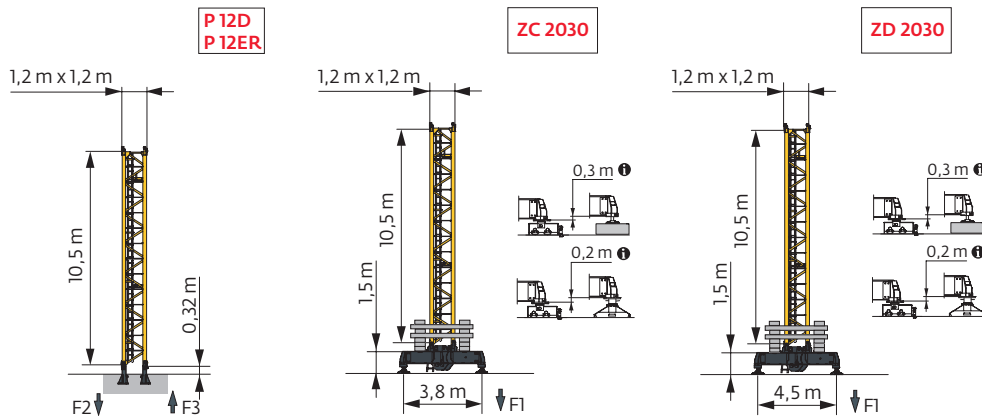

i Autres compositions de pylône - Nous consulter. / Andere Turmaufbauten - bitte kontaktieren Sie uns. / Other mast compositions - Please consult us. / Para otras composiciones de mástil - Por favor contáctenos. / Per altre composizioni torre, contattateci. / Para outras composições de coluna - Por favor, consulte-nos. / Для других композиций мачты пожалуйста консультируйтесь с нами.

Accès motorisés : compositions de mât, de lest de base et réactions adaptées. / Motorisierter Zugang vom : Mastzusammensetzung, Grundballast und Reaktionskräfte sind angepasst. / Motorized accesses: adapted mast composition, base ballast and reactions. / Acceso a cabina con elevador: Adaptación de composición de mástil, lastre de base y reacciones. / Accessi motorizzati: composizioni elementi torre, zavorre di base e reazioni aggiornate. / Acessos motorizados: composições de coluna, lastro da base e reacções adaptadas. / Лифты : адаптированная композиция мачты, базовый балласт и нагрузки.

1,2 m City - P 24A - C25

ΔΔΔΔ (m)	25	30	35	40	45	50	55
⚡ (m)	44,4	44,4	44,4	44,4	44,4	44,4	44,4
⚡/P+ (m)	44,4	44,4	44,4	44,4	44,4	44,4	44,4
	1,5 m	1	1	1	1	1	1
	5 m	7	7	7	7	7	7
	10 m	1	1	1	1	1	1
F2 (t)	●	105	104	102	105	109	110
	■	177	177	178	181	181	182
F3 (t)	●	82	80	78	79	83	83
	■	157	156	156	159	158	157

⚡ (m) D25	39,4	39,4	39,4	39,4	39,4	39,4	39,4
⚡/P+ (m) D25	39,4	39,4	39,4	39,4	39,4	39,4	39,4

1,6 m City - P 42A - C25

ΔΔΔΔ (m)	25	30	35	40	45	50	55
⚡ (m)	56,2	56,2	56,2	56,2	56,2	54,5	54,5
⚡/P+ (m)	56,2	56,2	56,2	56,2	56,2	54,5	54,5
	3,33 m	1	1	1	1	2	2
	5 m	9	9	9	9	8	8
	10 m	1	1	1	1	1	1
F2 (t)	●	101	100	98	100	104	103
	■	209	209	210	212	213	203
F3 (t)	●	76	74	72	73	76	75
	■	187	186	186	188	188	177

⚡ (m) D25	49,5	49,5	49,5	47,9	47,9	47,9	47,9
⚡/P+ (m) D25	49,5	49,5	49,5	47,9	47,9	47,9	47,9

1,6 m City - ZC 4230 - C25

ΔΔΔΔ (m)	25	30	35	40	45	50	55
⚡ (m)	41,2	41,2	41,2	41,2	41,2	42,9	42,9
⚡/P+ (m)	41,2	41,2	41,2	41,2	41,2	42,9	42,9
	3,33 m	2	2	2	2	1	1
	5 m	7	7	7	7	8	8
F1 (t)	●	57	57	55	56	58	61
	■	73	73	73	74	74	80

⚡ (m) D25	34,5	34,5	34,5	34,5	34,5	34,5	34,5
⚡/P+ (m) D25	34,5	34,5	34,5	34,5	34,5	34,5	34,5

1,6 m City - ZD 4230 - C25

ΔΔΔΔ (m)	25	30	35	40	45	50	55
⚡ (m)	44,5	44,5	44,5	44,5	44,5	44,5	46,2
⚡/P+ (m)	44,5	44,5	44,5	44,5	44,5	44,5	46,2
	3,33 m	0	0	0	0	0	2
	5 m	9	9	9	9	9	8
F1 (t)	●	54	54	54	54	54	60
	■	73	72	73	74	74	82

⚡ (m) D25	37,9	37,9	37,9	37,9	39,5	39,5	39,5
⚡/P+ (m) D25	37,9	37,9	37,9	37,9	39,5	39,5	39,5

1,6 m - P 42A - C25

ΔΔΔΔ (m)	25	30	35	40	45	50	55
⚡ (m)	54,9	54,9	54,9	53,2	53,2	53,2	53,2
⚡/P+ (m)	54,9	54,9	54,9	53,2	53,2	53,2	53,2
	2 m	1	1	1	1	1	1
	3,33 m	0	0	0	1	1	1
	5 m	9	9	9	8	8	8
	10 m	1	1	1	1	1	1
F2 (t)	●	103	102	100	100	104	105
	■	216	216	216	209	209	210
F3 (t)	●	75	73	71	70	73	74
	■	190	190	190	182	181	181

⚡ (m) D25	46,5	46,5	46,5	46,5	46,5	46,5	46,5
⚡/P+ (m) D25	46,5	46,5	46,5	46,5	46,5	46,5	46,5

1,6 m - S 41A - C25

ΔΔΔΔ (m)	25	30	35	40	45	50	55
⚡ (m)	48,6	50,3	50,3	50,3	50,3	50,3	50,3
⚡/P+ (m)	48,6	50,3	50,3	50,3	50,3	50,3	50,3
	2 m	1	1	1	1	1	1
	3,33 m	0	2	2	2	2	2
	5 m	9	8	8	8	8	8
F1 (t)	●	64	69	69	69	71	72
	■	94	103	103	104	104	104

⚡ (m) D25	42	42	42	42	42	42	42
⚡/P+ (m) D25	42	42	42	42	42	42	42

P 24A / P 42A

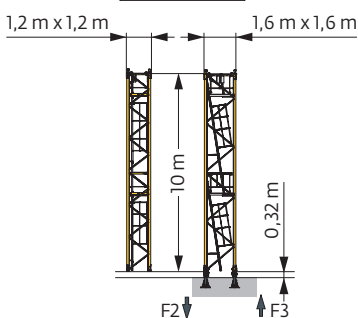

S 41A

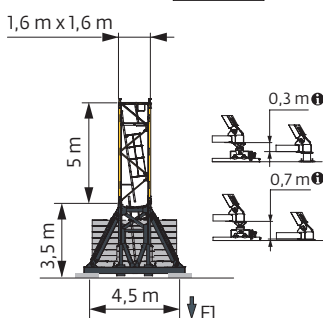

ZC 4230

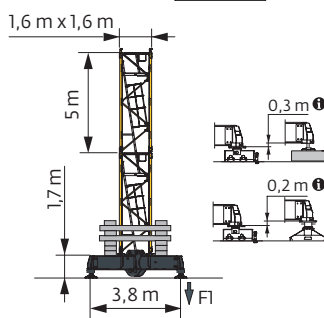

ZD 4230

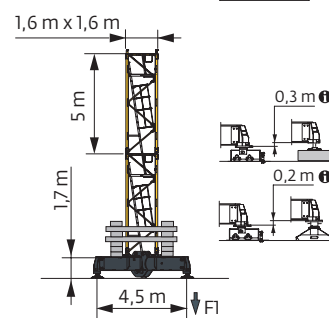

Ancrages / Verankerungen / Anchorages / Anclajes / Ancoraggi
 Ancoragem / нкре

P 42A - C25

AK 400

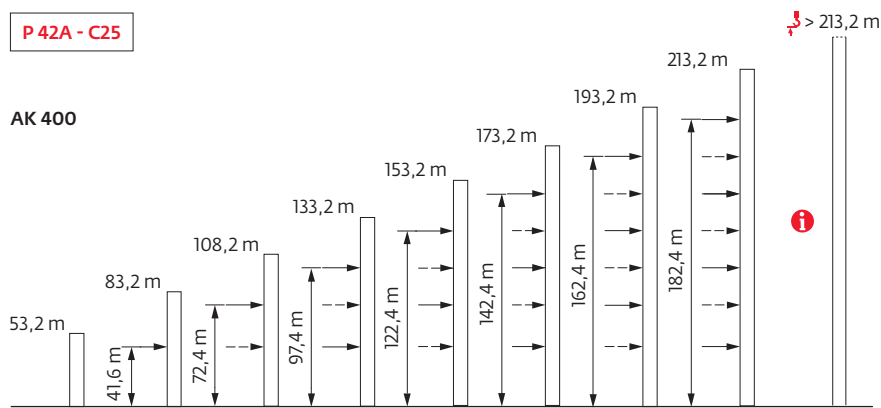

Lest de base / Grundballast / Base ballast / Lastre de base / Zavorra di base
 Lastro da base / Базовый Балласт

⚙️ (t) / 1,2 m City - ZC 2030 - 🏗️ - C25							
⚙️ (m)	25	30	35	40	45	50	55
35,4	65	65	60	65	60	65	65
27,9	45	45	45	45	45	45	45
20,4	45	45	45	45	45	45	45

⚙️ (t) / 1,2 m City - ZD 2030 - 🏗️ - C25							
⚙️ (m)	25	30	35	40	45	50	55
35,4	50	45	45	45	45	45	45
27,9	45	45	45	45	45	45	45
20,4	45	45	45	45	45	45	45

⚙️ (t) / 1,6 m City - ZC 4230 - 🏗️ - C25							
⚙️ (m)	25	30	35	40	45	50	55
42,9						80	80
41,2	80	80	75	75	75	75	70
36,2	50	50	50	50	55	55	55
31,2	45	45	45	45	45	45	45
26,2	45	45	45	45	45	45	45
21,2	45	45	45	45	45	45	45

⚙️ (t) / 1,6 m City - ZD 4230 - 🏗️ - C25							
⚙️ (m)	25	30	35	40	45	50	55
46,2							80
44,5	75	75	75	75	70	70	70
39,5	50	45	45	45	45	45	45
34,5	45	45	45	45	45	45	45
29,5	45	45	45	45	45	45	45
24,5	45	45	45	45	45	45	45
19,5	45	45	45	45	45	45	45

⚙️ (t) / 1,6 m - S 41A - 🏗️ - C25							
⚙️ (m)	25	30	35	40	45	50	55
50,3		114	114	114	114	114	114
48,6	102	102	102	102	102	102	96
43,6	72	72	72	72	72	66	66
38,6	48	48	48	48	48	42	42
33,6	42	42	42	42	42	42	42
28,6	42	42	42	42	42	42	42
23,6	42	42	42	42	42	42	42
18,6	42	42	42	42	42	42	42

Courbes de charges / Lastkurven / Load curves / Curvas de cargas / Curve di carico
Curvas de carga / Кривые нагрузок



▼▲▲▲▲ (m)		15	17	20	22	25	27	30	32	35	37	40	42	45	47	50	52	55	m	
▼▲▲▲	↔ 6 t	↔ 3 t						↔												
▼▲▲▲	↔ 3 t																			
55	2,8 → 16,4	29,7 - 33	6	5,8	4,8	4,3	3,7	3,4	3	3	2,8	2,65	2,4	2,25	2	1,85	1,6	1,45	1,3	t
	2,8 → 16,4	29,7 - 33	6	5,7	4,8	4,3	3,7	3,4	3	3	2,8	2,65	2,4	2,3	2,05	1,9	1,7	1,55	1,35	t P+
50	2,8 → 16,3	29,5 - 33	6	5,7	4,8	4,3	3,7	3,3	3	3	2,8	2,6	2,4	2,25	2,1	2	1,85			t
	2,8 → 16,3	29,5 - 33	6	5,7	4,8	4,3	3,7	3,3	3	3	2,8	2,6	2,4	2,25	2,1	2	1,85			t P+
45	2,8 → 16,4	29,6 - 33	6	5,7	4,8	4,3	3,7	3,4	3	3	2,8	2,65	2,4	2,25	2,1					t
	2,8 → 16,4	29,6 - 33	6	5,7	4,8	4,3	3,7	3,4	3	3	2,8	2,65	2,4	2,25	2,1					t P+
40	2,8 → 16,6	29,6 - 33	6	5,8	4,8	4,3	3,7	3,3	3	3	2,8	2,6	2,4							t
	2,8 → 16,6	29,6 - 33	6	5,8	4,8	4,3	3,7	3,3	3	3	2,8	2,6	2,4							t P+
35	2,8 → 16,8	30,3 - 33,6	6	5,8	4,9	4,4	3,8	3,5	3	3	2,85									t
	2,8 → 16,8	30,3 - 33,6	6	5,8	4,9	4,4	3,8	3,5	3	3	2,85									t P+
30	2,8 → 17,3		6	6	5	4,5	3,8	3,5	3											
	2,8 → 17,3		6	6	5	4,5	3,8	3,5	3											t P+
25	2,8 → 17,3		6	6	5	4,5	3,8													
	2,8 → 17,3		6	6	5	4,5	3,8													t P+

↔ = ↔ - 0,39 t max.



▼▲▲▲▲ (m)		15	17	20	22	25	27	30	32	35	37	40	42	45	47	50	52	55	m	
▼▲▲▲	↔ 6 t	↔ 3 t						↔												
▼▲▲▲	↔ 3 t																			
55	2,2 → 16,8	31,3 - 32	6	5,9	5	4,5	3,9	3,6	3,1	3	2,7	2,5	2,3	2,15	1,9	1,7	1,5	1,35	1,15	t
	2,2 → 16,8	31,3 - 32	6	5,9	5	4,5	3,9	3,5	3,1	3	2,7	2,5	2,3	2,15	1,95	1,8	1,55	1,4	1,25	t P+
50	2,2 → 16,8	31,1 - 31,6	6	5,9	5	4,5	3,9	3,5	3,1	2,95	2,65	2,5	2,25	2,15	1,95	1,85	1,7			t
	2,2 → 16,8	31,1 - 31,6	6	5,9	5	4,5	3,9	3,5	3,1	2,95	2,65	2,5	2,25	2,15	1,95	1,85	1,7			t P+
45	2,2 → 16,8	31,2 - 31,7	6	5,9	5	4,5	3,9	3,5	3,1	2,95	2,65	2,5	2,3	2,15	1,95					t
	2,2 → 16,8	31,2 - 31,7	6	5,9	5	4,5	3,9	3,5	3,1	2,95	2,65	2,5	2,3	2,15	1,95					t P+
40	2,2 → 17	31,1 - 31,6	6	6	5	4,5	3,9	3,5	3,1	2,95	2,65	2,5	2,25							t
	2,2 → 17	31,1 - 31,6	6	6	5	4,5	3,9	3,5	3,1	2,95	2,65	2,5	2,25							t P+
35	2,2 → 17,3	31,9 - 32,5	6	6	5,1	4,6	4	3,6	3,2	3	2,75									t
	2,2 → 17,3	31,9 - 32,5	6	6	5,1	4,6	4	3,6	3,2	3	2,75									t P+
30	2,2 → 17,8		6	6	5,2	4,7	4	3,6	3,2											t
	2,2 → 17,8		6	6	5,2	4,7	4	3,6	3,2											t P+
25	2,2 → 17,8		6	6	5,2	4,7	4													t
	2,2 → 17,8		6	6	5,2	4,7	4													t P+

↔ = ↔ - 0,08 t max.

Poids de flèche & lest de contre-flèche / Auslegergewicht & Gegenauslegerballast / Jib weight & counter-jib ballast / Peso de flecha y lastre de contra-flecha / Peso del braccio & zavorra di contro-braccio / Peso da lança & lastro da contra-lança
Вес стрелы и балласт контр-стрелы

▼▲▲▲	▼▲▲▲▲ (kg) - 25 LVF (+/- 5%)			▼▲▲▲		▼▲▲▲ (kg)
	↔ 3 t	↔	↔ 3 t	3600 kg	1100 kg	
55 m	7660	7540	7835	3	6	17400
50 m	7465	7345	7635	3	5	16300
45 m	7230	7110	7400	3	4	15200
40 m	6930	6810	7105	3	3	14100
35 m	6585	6465	6760	3	2	13000
30 m	6330	6210	6505	3	1	11900
25 m	6045	5925	6220	3	0	10800

CAU - 3600 kg

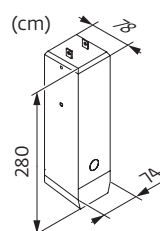

CAV - 1100 kg

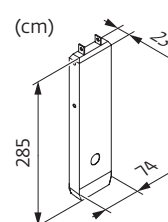





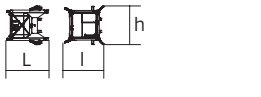
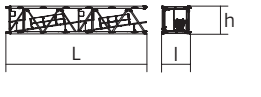
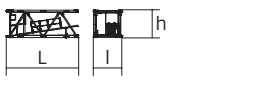
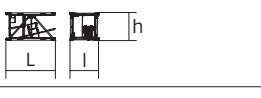
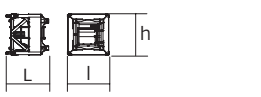

Encombremet et poids / Abmessungen und Gewicht / Dimensions and weight / Dimensiones y peso / Ingombro e peso
 dimensões e pesos / габаритные размеры и вес

Partie tournante / Drehender Kranteil / Slewing crane part / Parte giratoria
 Parte rotante / Parte rotativa / Поворотная часть : 55 м - 25 LVF

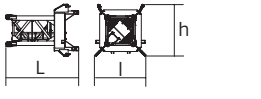

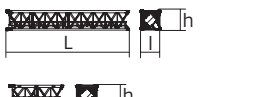
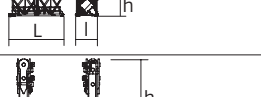
Partie tournante / Drehender Kranteil / Slewing crane part Parte giratoria / Parte rotante / Parte rotativa Поворотная часть		L (m)	l (m)	h (m)	kg (+/- 5%)	
Contre-flèche / Gegenausleger Counter-jib / Contra-flecha Controbraccio / Contra-lança Контр-стрела		1,2 m	11,96	2,07	2,47	5580
		1,6 m	11,96	2,16	2,7	5730
Cabine / Kabine Cab / Cabina Cabina / Cabina Кабина		Ultra View	3,16	1,98	3,63	995
Elément de flèche / Auslegerement Jib section / Elemento de flecha Elemento di braccio / Elemento de lança Секция стрелы		① 25 LVF 6 DVF	10,61	2,68	2,61	3290
Elément de flèche / Auslegerement Jib section / Elemento de flecha Elemento di braccio / Elemento de lança Секция стрелы		④	5,18	1,05	1,92	400
		⑤	5,17	1,05	1,91	345
		⑥	5,17	1,05	1,89	345
		⑧	5,16	1,05	1,19	230
Elément de flèche / Auslegerement Jib section / Elemento de flecha Elemento di braccio / Elemento de lança Секция стрелы		②	10,2	1,05	2,34	1370
Elément de flèche / Auslegerement Jib section / Elemento de flecha Elemento di braccio / Elemento de lança Секция стрелы		③	5,19	1,05	2,33	450
		⑦	5,16	1,05	1,9	295
Elément de flèche / Auslegerement Jib section / Elemento de flecha Elemento di braccio / Elemento de lança Секция стрелы		⑨	5,09	1,05	1,17	190
Treuil de levage (+ câble) / Hubwerk (+ Seil) Hoisting winch (+ rope) / Mecanismo de elevación (+ cabo) Argano di sollevamento (+ fune) Guincho de elevação (+ cabo) Подъемная лебедка (+ канатом)		25 LVF	1,33	0,7	0,71	765
		33 LVF	1,36	0,92	0,89	965
Chariot / Laufkatze Trolley / Carrello Carro / Carro-distribuidor Тележка			1,58	1,33	0,87	280
Moufle / Hubflasche Pulley block / Aparejo Bozzello / Cadernal Полиспаст			0,9	0,26	1,32	285
Chariot / Laufkatze Trolley / Carrello Carro / Carro-distribuidor Тележка			1,39	1,26	0,95	280
			1,42	1,26	0,95	280
Chariot / Laufkatze Trolley / Carrello Carro / Carro-distribuidor Тележка			1,51	1,3	0,95	235
			1,26	0,27	1,53	250
Moufle / Hubflasche Pulley block / Aparejo Bozzello / Cadernal Полиспаст			0,78	0,22	1,29	130

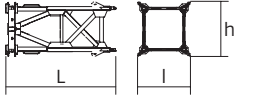
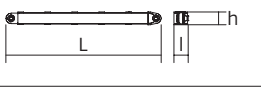
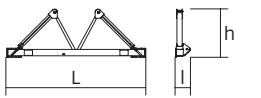
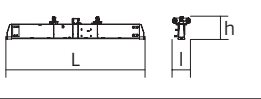
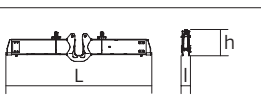
Pyłone / Kranturm / Crane tower Mástil / Torre / Torre Башня крана		L (m)	l (m)	h (m)	kg (+/- 5%)
T 41		10,85	3,73	4,1	7100
K40/K40-2 Mât de télescopage / Teleskopiermast Telescoping mast / Tramo de telescopaje Elemento di telescopaggio / Tramo de Telescopagem Мачта для телескопирования		2,21	2,1	2,06	1330
K 447E KM 447E KM 449E		10,21 10,21 10,21	1,62 1,62 1,62	1,62 1,62 1,62	3390 3215 4005
K 447A KMT 447A K 449A KMT 449A		5,21 5,21 5,21 5,21	1,67 1,67 1,67 1,67	1,62 1,62 1,62 1,62	1850 1745 2230 2130
K 447C KMT 447C		3,45 3,54	1,67 1,67	1,62 1,62	1360 1350
K20/K40 Mât raccord / Verbindungsmast Connecting mast / Tramo unión Elemento raccordo / Tramo raccordo Переходная мачта		1,7	1,64	1,64	1900
KM 247E KM 249E		10,21 10,21	1,23 1,23	1,23 1,23	3250 4000
KM 247A KM 249A		5,21 5,21	1,23 1,23	1,23 1,23	1700 2100
K40/L20-2 Mât raccord / Verbindungsmast Connecting mast / Tramo unión Elemento raccordo / Tramo raccordo Переходная мачта		2,95	2,06	2,1	2100
S 28ES-2 SR 26E-2 SR 28ER-2		10,75 10,75 10,75	1,27 1,27 1,27	1,27 1,27 1,27	3450 3055 4105
SR 25F-2		7,75	1,27	1,27	2015
SR 26X-2		3,25	1,26	1,26	985
Pieds de scellement / VerankerungsfüÙe Fixing angles / Pie de empotramiento Montante da annegare / Angulos fixadores анкера		0,49 0,8 0,56	0,49 0,8 0,56	1,12 1,31 1,17	165 420 240
Mât-châssis / Grundmasteinheit Basic mast unit / Tramo-chassis Elemento base / Tramo-chassis Мачта для крепления к шасси		3,63	1,96	2,08	3235
Haubans / Mastabstützungen Struts / Tornapuntas Puntoni / Escoras Растяжка		3,18	0,26	0,24	370
Sommier / Unterwagenhälfte Half-bearer / Testero Testata / Estrutura base Траверса		5,1	0,6	1,78	1050
Bras de croix / Fundamentkruzträger Cross girder / Brazo en cruz Braccio croce / Braço da cruz Поперечная балка		5,63 6,62 5,64 6,63	0,82 0,82 0,82 0,82	1,16 1,16 1,05 1,05	1500 1690 1590 1830
Bras de croix / Fundamentkruzträger Cross girder / Brazo en cruz Braccio croce / Braço da cruz Поперечная балка		5,63 6,62 5,64 6,63	0,47 0,47 0,47 0,47	1,45 1,45 1,34 1,34	1735 1930 1895 2135

Mécanismes / Triebwerke / Mechanisms / Mecanismos / Meccanismi
 Механизмы / Механизмы

400 V - 50 Hz										ch - PS hp	kW		
	25 LVF 15 Optima	m/min	29,5	39	54,5	70	15	20	28	35	25	18	278 m
		t	3	2,25	1,5	0,75	6	4,5	3	1,6			
	33 LVF 15 Optima	m/min	36	47	67,5	96	18	24	35,5	48	33	22	305 m
		t	3	2,25	1,5	0,55	6	4,5	3	1,3			
	6 DVF 4 Optima	m/min	0 → 80 (6 t) 0 → 100 (2 t)										
	RVF 152 Optima+	tr/min U/min rpm	0 → 0,8				2 x 5,5 2 x 4						

	IEC 60204-32		kVA
400 V (+10% -10%) 50 Hz		25 LVF : 34 → 24 kVA 33 LVF : 41 → 28 kVA	

25 LVF 15 Optima

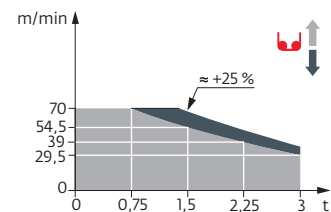

33 LVF 15 Optima

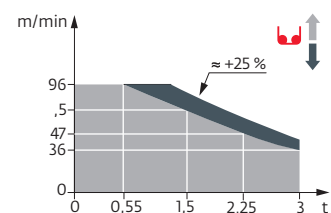

	FR	DE	EN	ES	IT	PT	RU
	Profil de vent suivant EN 14439 C25-D25	Windbedingungen gemäss EN 14439 C25-D25	Wind conditions according to EN 14439 C25-D25	Conformidad de los condiciones de viento EN 14439 C25-D25	Condizioni del vento secondo EN 14439 C25-D25	Perfil de vento conforme EN 14439 C25-D25	Ветровой режим в соответствии с EN 14439 C25-D25
	Appel de flèche	Auslegerüberhöhung	Jib elevation	Elevación de la flecha	Inclinazione braccio	Desvio da lança	подъем стрелы
	Équipements standards	Standardausrüstungen	Standard equipment	Equipamiento de serie	Equipaggiamento standard	Equipamento de série	Стандартное оборудование
	Équipements optionnels	Sonderausrüstungen	Options	Equipamiento opcional	Equipaggiamento in opzione	Equipamento opcional	Дополнительное оборудование (опция)
	Fonction Potain Plus : Courbes de charges Plus	Funktion Potain Plus: Plus-Lastkurven	Potain Plus function: Plus load curves	Función Potain Plus: Diagrama de cargas Plus	Funzione Potain Plus: Curve di carico Plus	Função Potain Plus: Diagrama de cargas Plus	Функция контроля мощности Potain Plus: Диаграммы грузоподъемности Plus
	Hauteurs sous crochet associées aux courbes de charges Plus	Hakenhöhen mit Plus-Lastkurven	Hook heights with Plus load curves	Altura bajo gancho, usando el diagrama de cargas Plus	Altezze sotto gancio con curve di carico Plus	Altura livre, utilizando o diagrama de cargas Plus	Высота под крюком для диаграмм грузоподъемности Plus
	Réactions en service	Reaktionskräfte in Betrieb	Reactions in service	Reacciones en servicio	Reazioni in servizio	Reacções em serviço	Реакция при работе
	Réactions hors service	Reaktionskräfte außer Betrieb	Reactions out of service	Reacciones fuera de servicio	Reazioni fuori servizio	Reacções fora de serviço	Реакция в покое
	Poids total du lest	Ballast-Gesamtgewicht	Total ballast weight	Peso total del lastre	Peso totale della zavorra	Peso total do lastro	Общий вес балласта
	Cadre d'ancrage serré	Fester Verankerungsrahmen	Tightened anchorage frame	Marco de anclaje de apriete	Quadro di ancoraggio stretto	Quadro de amarração apertado	Прикрепленная анкерная рама
	Cadre d'ancrage desserré	Loser Verankerungsrahmen	Loosened anchorage frame	Marco de anclaje de desapriete	Quadro di ancoraggio allentato	Quadro de amarração solto	Отсоединенная анкерная рама
	Poids de flèche	Auslegergewicht	Jib weight	Peso de flecha	Peso del braccio	Peso da lança	вес стрелы
	Camion 13,4 m	Lkw 13,4 m	Lorry 13,4 m	Camión 13,4 m	Camion 13,4 m	Camião 13,4 m	Рзусовой автомобиль 13,4 м
	Conteneur High Cube 40', et/ou Flat Rack 20'	Container High Cube 40', und/oder Flat Rack 20'	Container High Cube 40', and/or Flat Rack 20'	Contenedor High Cube 40', y/o Flat Rack 20'	Container High Cube 40', e/o Flat Rack 20'	Contentor High Cube 40', e/ou Flat Rack 20'	40-футовый контейнер повышенной вместимости High Cube, и/или 20-футовая открытая платформа Flat Rack
	Levage	Heben	Hoisting	Elevación	Sollevamento	Elevação	Подъем
	Distribution	Katzfahren	Trolleying	Distribución	Distribuzione	Distribuição	Перемещение по стреле
	Orientation	Schwenken	Slewing	Orientación	Rotazione	Rotação	Поворот
	Translation	Kranfahren	Travelling	Traslación	Traslazione	Translação	Перемещение крана
	Puissance requise	Erforderliche Leistung	Required power	Potencia Necesaria	Potenza richiesta	Potência Necessária	Потребляемая мощность
	Fonction Power Control : vitesses treuils adaptées à la puissance disponible	Funktion Power Control: Geschwindigkeiten der Triebwerke werden an die verfügbare Leistung angepasst	Power Control Function: winch speeds adapted to the available power	Función Power Control: marchas de los cabrestantes adaptadas a la potencia disponible	Funzione Power Control: velocità degli argani adattate alla potenza disponibile	Função Power Control: velocidades de guincho adaptadas à potência disponível	Функция контроля мощности Power Control: регулировка скорости лебедок в зависимости от доступной мощности
	Nous consulter	Auf Anfrage	Consult us	Consultarnos	Consultateci	Consultar-nos	Проконсультируйтесь у нас
	Document commercial non contractuel. Pour toute information technique se référer à la notice correspondante.	Unverbindliches Vertriebsdokument. Für technische Informationen, siehe die entsprechenden Anweisungen.	This commercial document is not legally binding. For any technical information, please refer to the corresponding instructions.	Documento comercial no contractual. Para cualquier información técnica, ver la noticia correspondiente.	Documento commerciale non vincolante, per tutte le informazioni tecniche fare riferimento al catalogo istruzioni.	Documento comercial não contractual. Para qualquer informação técnica complementar consultar as respectivas instruções.	Этот коммерческий документ не является юридически обязательным. Для получения технической информации, см. соответствующие инструкции.

